

型号 Ordering Code	90度接头 90° unions															
	A	B	ø D	E	ø F1	ø F2	ø G	H	I	L	ø P	Q	U	ø V	Z	KG.
B08-1501-04R	M16 X 1,5 RH	G 1/4"	5	101	44	49	24,5	17	16	76	18	4,5	49	52	49	0,6
B08-1501-05L	M16 X 1,5 LH															
B10-1701-04R	M16 X 1,5 RH	G 3/8"	9	115	54	59,5	24,5	17	16	87	18	4,5	59,5	63	56,5	0,8
B10-1701-05L	M16 X 1,5 LH															

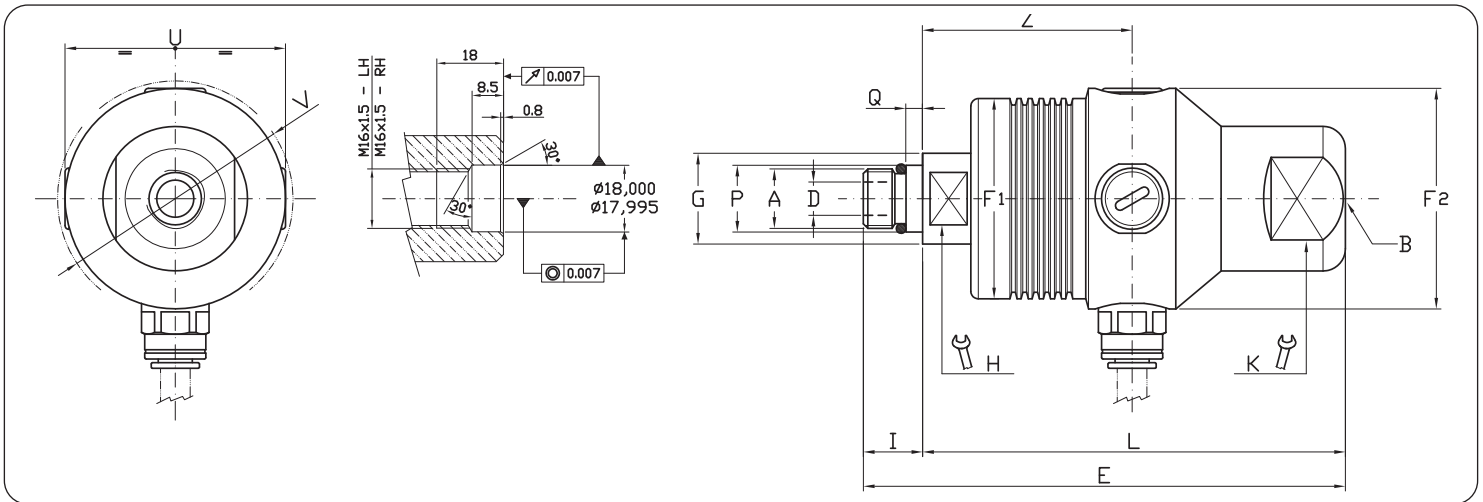

型号 Ordering Code	直式接头 Straight through unions																
	A	B	ø D	E	ø F1	ø F2	ø G	H	K	I	L	ø P	Q	U	ø V	Z	KG.
B08-1502-04R	M16 X 1,5 RH	G 1/4"	5	116	44	49	24,5	17	24	16	100	18	4,5	49	52	49	0,6
B08-1502-05L	M16 X 1,5 LH																
B10-1702-04R	M16 X 1,5 RH	G 3/8"	9	130	54	59,5	24,5	17	32	16	114	18	4,5	59,5	63	56,5	0,8
B10-1702-05L	M16 X 1,5 LH																